

LOADER

Smart Electric Vehicle Charging



Christos Stefanatos
Product Lead
evloader.com



Why EVs are the future ?



Internal combustion Engine (ICE)

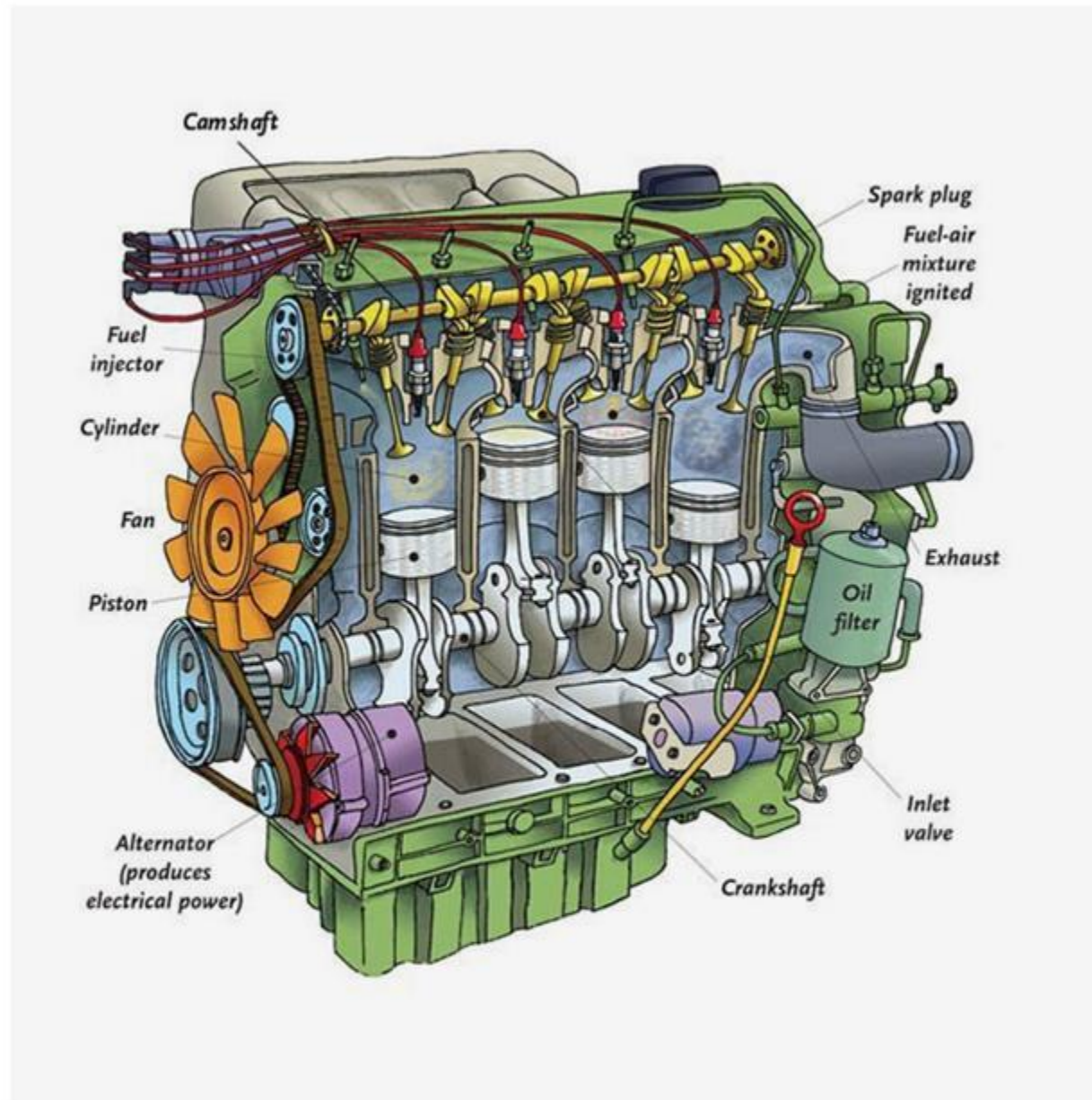

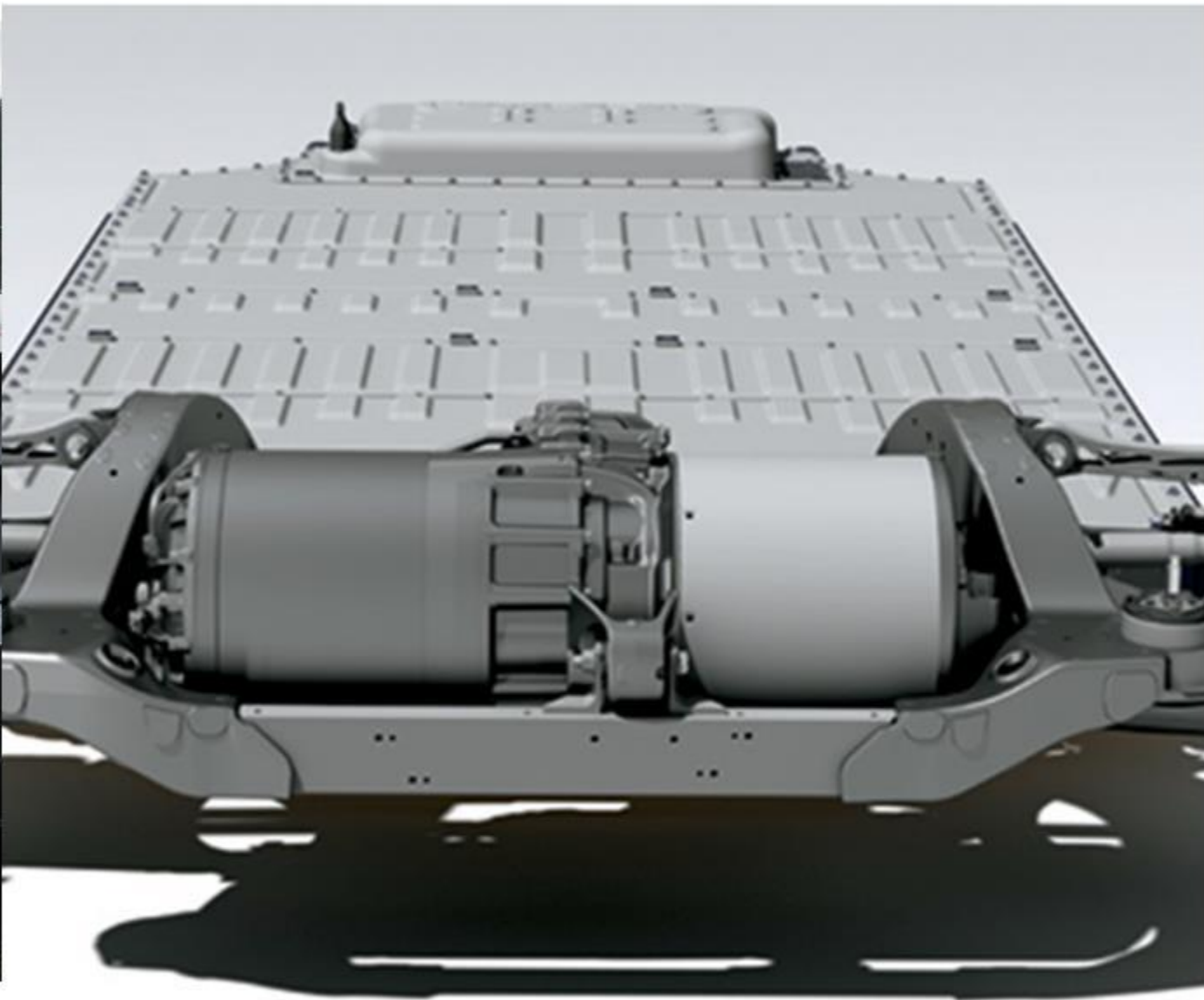

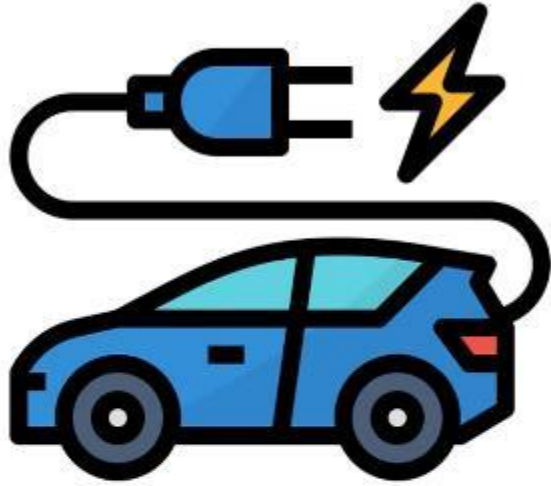

Lower Maintenance costs

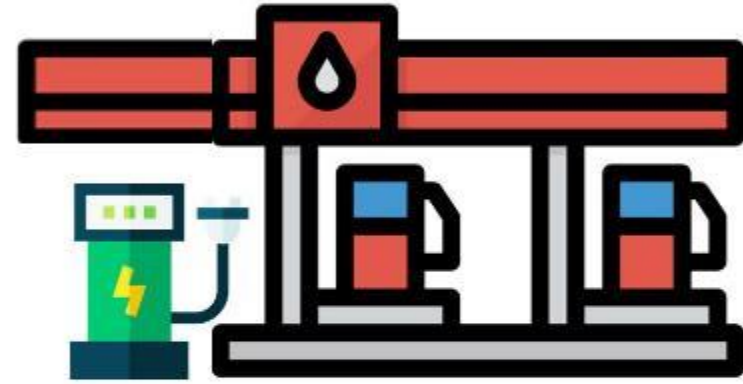

Per 100km: 3 € for EV vs 10 € ICE

■ LOADER

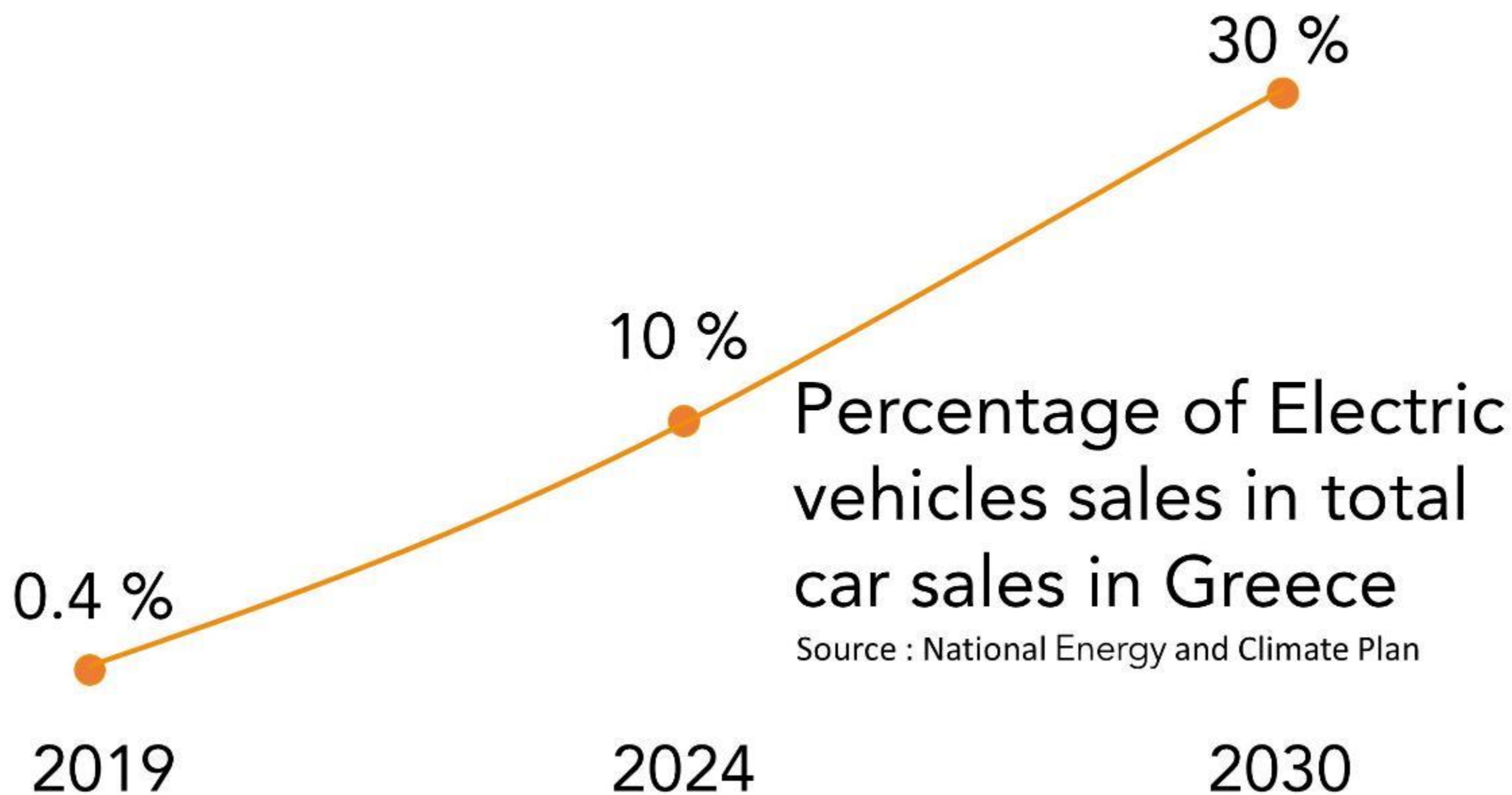

Challenges for EVs





Charging in US suburbs



Charging in Greek Cities

Where will I charge?



Home Charging



Destination Charging



On-route Charging

Challenge: How is the driver going to pay in 3rd party managed charging stations?

How will the driver identify and operate chargers?

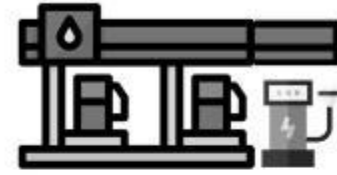

EV Loader: Charging station management software solution



 **LOADER**

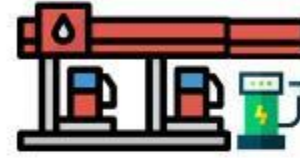

Visibility
Monitoring dashboard
Payments
Technical support
as a **Service**

LOADER

Charging Station Management



Offered to owners of charging stations via web and mobile app without subscription

Driver app



Drivers can register for free, perform charging sessions and reserve spots.

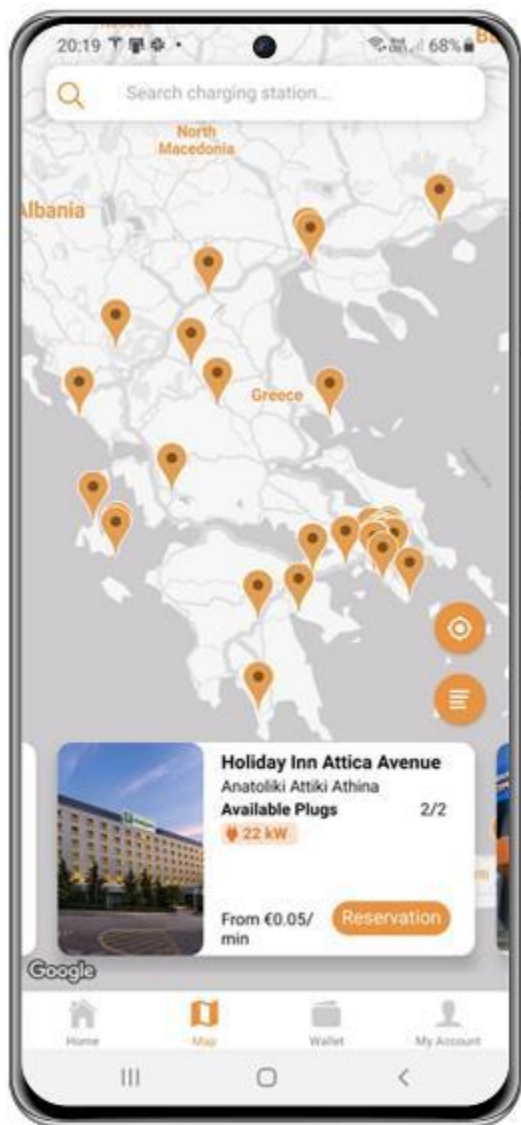

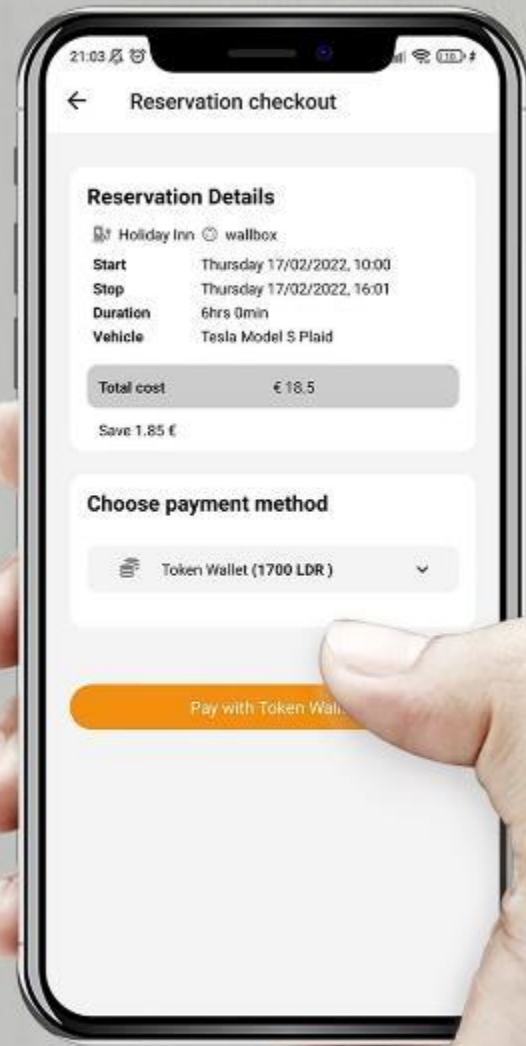



EV Loader manages chargers in more than 80 locations in Greece and Cyprus, focusing on hotels



Municipality of Athens



Holiday Inn



IBISCUS hotels



Clients: Hotel Groups



Clients: Boutique Hotels

Zagori, Epirus



Clients: Villas

Kefalonia





Skala,
Kefalonia

Smart Charging



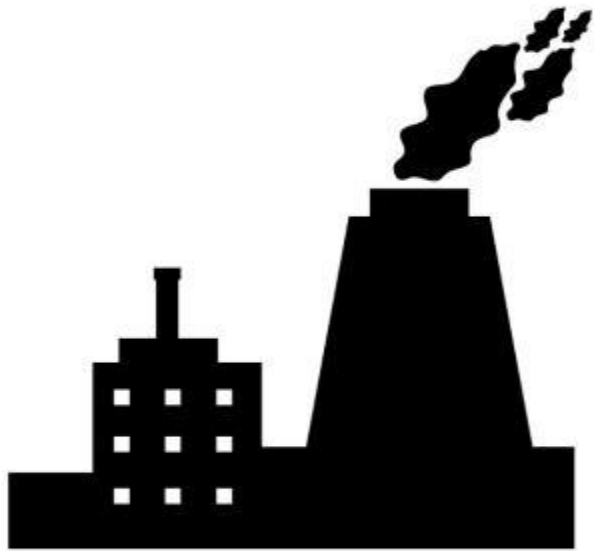

VS



SMART CHARGING

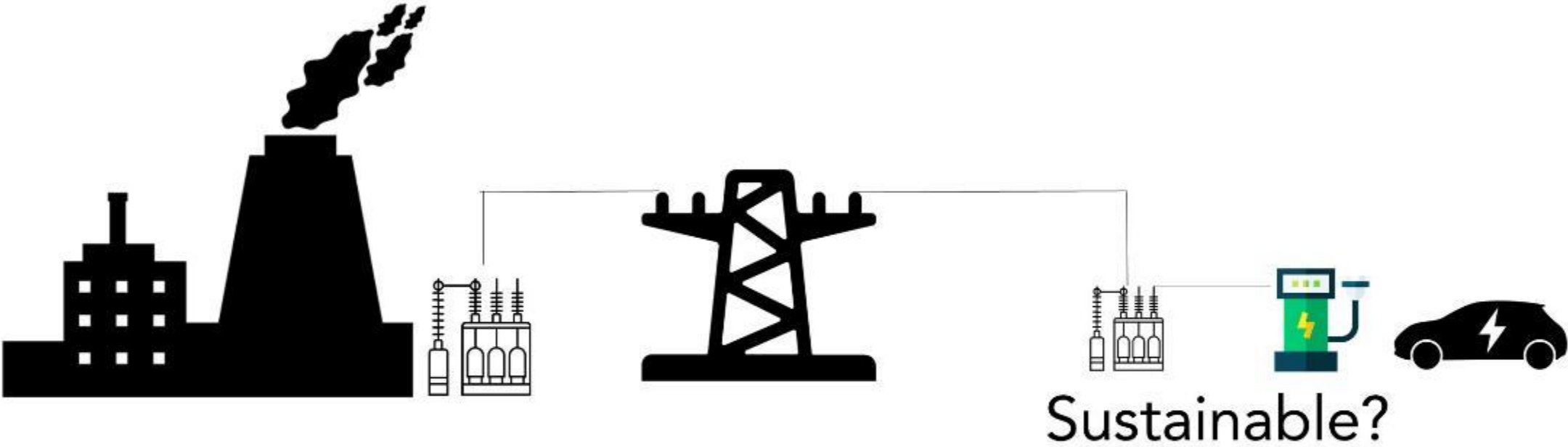

SMART CHARGING

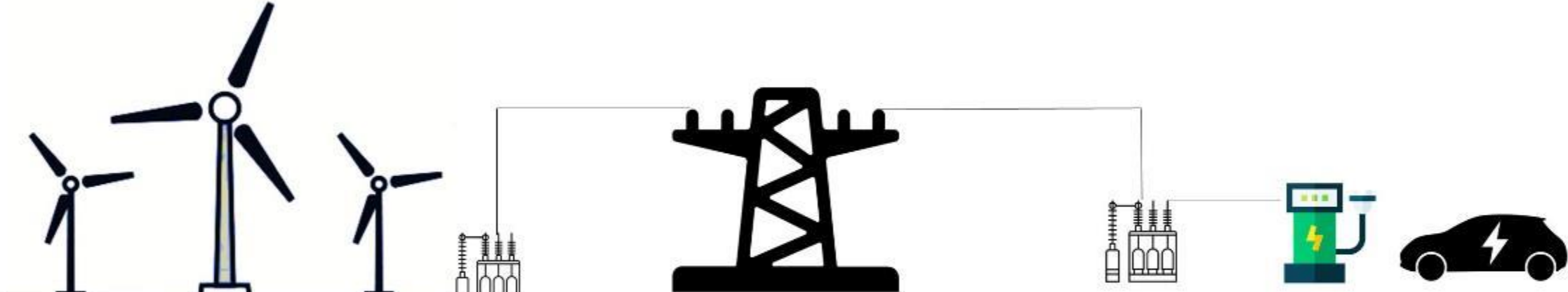

More Sustainable!

SMART CHARGING



Smart timing of electric vehicle charges can decrease curtailment of Green Energy

EXAMPLE

October 12th 2023 , 8.30 am

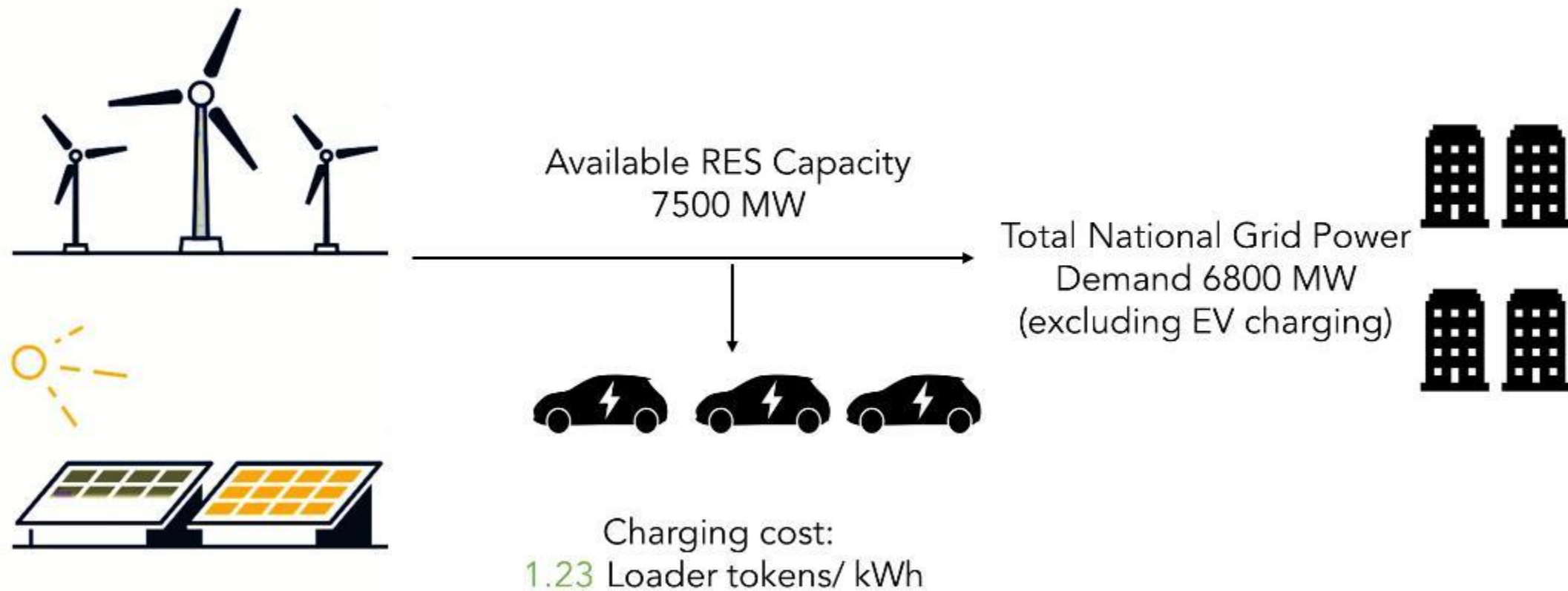

EXAMPLE

October 15th 2023 , 14.30 am

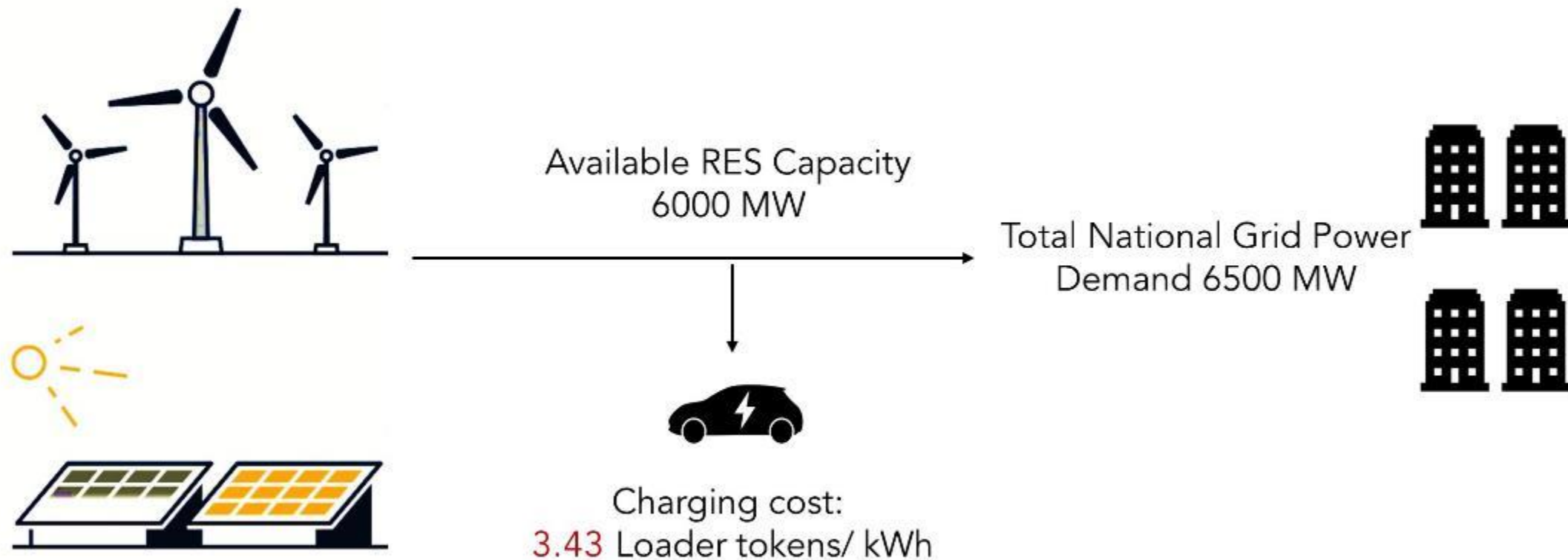

First implementation of smart charging incentives in SE Europe

 **LOADER**
evloader.com



HORIZON EUROPE



I-ENERGY Horizon 2020 Program [Link](#)



Electric future is now



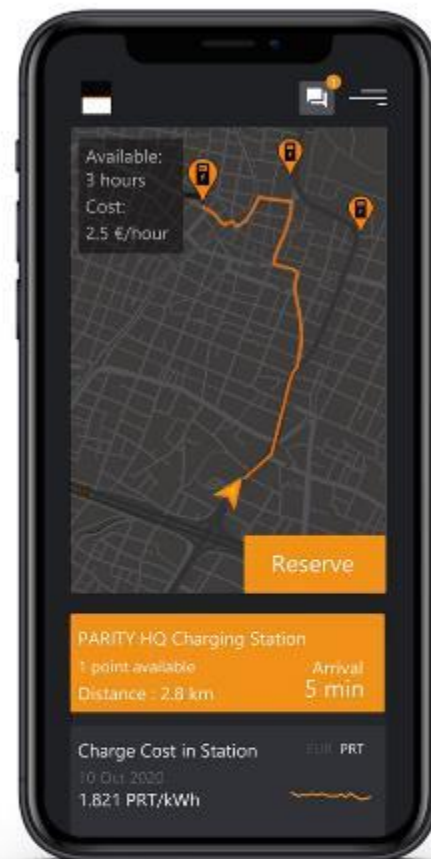

Visit the website:

evloader.com



C.Stefanatos@evloader.com



Christos Stefanatos

